



Promessa™ Series Rectangular Soap Basket Revised: 1/8/16
Installation Procedures For The Following Models:

**Model T100-001
Soap Basket**

T100-001-PC



T100-001-BN



T100-001-ORB



STEP 1 Understand Fastener

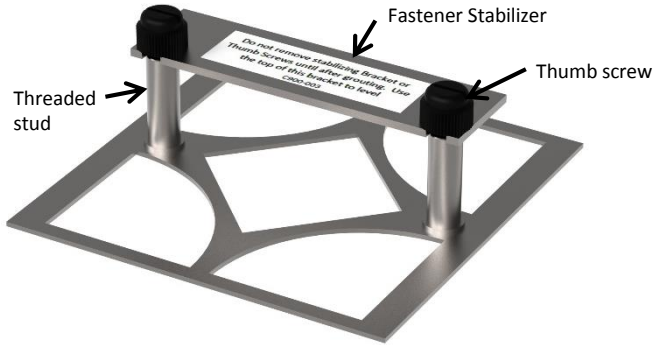

• Each PermaTile™ Fastener is equipped with a stabilizing bracket. The bracket ensures that basket mounts properly. Remove stabilizer after thin-set has met minimum cure times specified by manufacturer.

Warning: Each threaded stud is covered with a plastic thumb screw to prevent thin-set mortar from corrupting thread. Do not remove until after grouting.

Note: System will not work on tile thicknesses less than 5/32" or greater than 1/2"

STEP 2 Understanding Ferrules & Washers

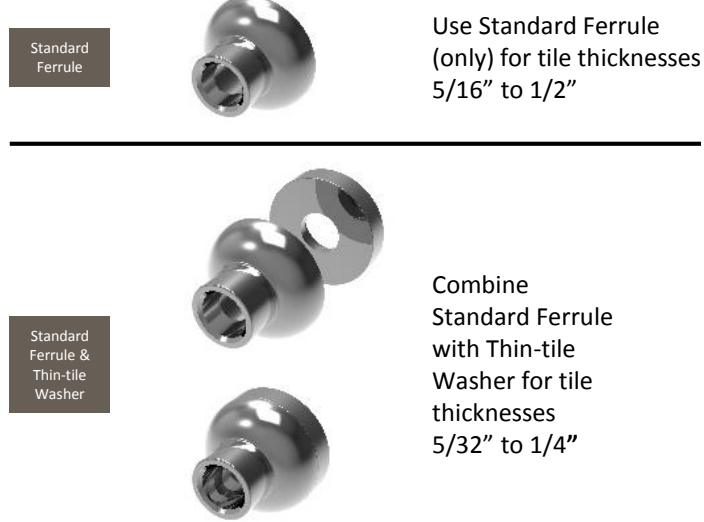

Warning: The success of this installation system requires that the tile professional clearly understands the thickness of a tile product. Failure to understand this requirement will lead to improper installation.

STEP 3 Determine Basket Location

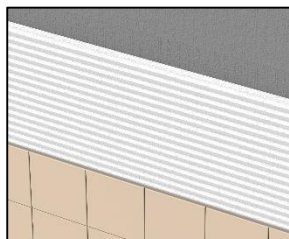

- Determine the wall surface where the PermaTile™ Fastener should be located.
- Apply thin-set mortar with no less than a 1/4" x 3/8" notch trowel.

Warning: Use only latex modified mortars that meet ANSI A118.4/A118.11 performance standard.

STEP 5 Mark & Notch Tiles

- Mark notch location.
- Carefully remove stabilizing bracket marking left & right side notch locations. Using an angle grinder, remove enough material allowing 1/16" of adjustment, side to side and up and down.

Warning: Notches and holes should not exceed 3/8" in diameter to ensure trim has sufficient surface area during mounting.

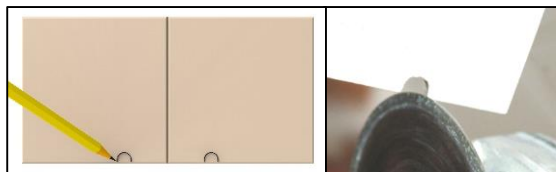

STEP 4 Install PermaTile™ Fastener

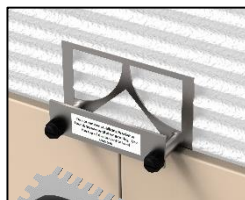

- Key thin-set mortar into the back side of tile to ensure proper contact and adhesion.
- Press the PermaTile™ Fastener into the combed thin-set mortar at the predetermined location.

Technical Fact:

Procedures for installing PermaTile™ Fastener in the body of the tile. Use only 10mm diamond drill bit (core).
Notch or drill 3/8" or 10mm so basket trim covers holes

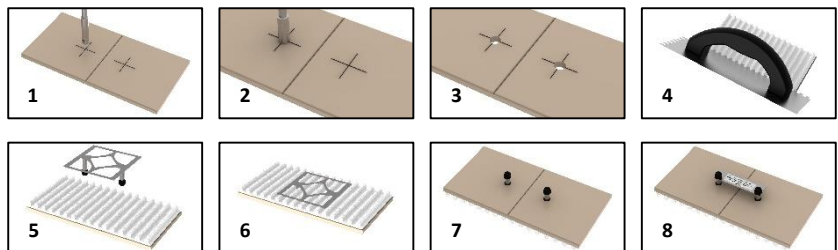



Promessa™ Series Rectangular Soap Basket Installation Procedures For The Following Models:

STEP 6 Install Notched Tiles

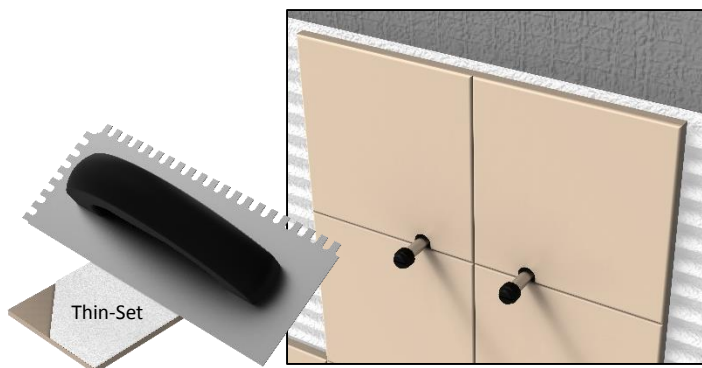

- Install notched tile, key thin-set mortar into the back side of tile to ensure proper contact and adhesion. Press tile into wall and adjust as necessary.

STEP 8 Install Trim

- Immediately proceed to accessory mounting after grouting is completed.
- Simply slip ferrules or ferrules & washers over studs.



STEP 10 Install Caps



- Install decorative brass caps. Easier if all prongs enter hole then press firmly.

STEP 7 Remount Stabilizer

- Remount metal stabilizing bracket as shown and ***tighten thumb screws securely.***
- Proceed with tile installation.

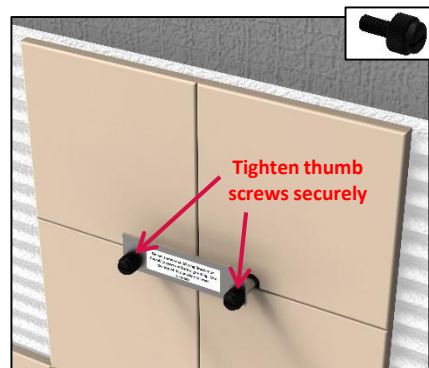

Not using stabilizer will result in basket mounting failure

STEP 9 Mount Screws



- Install stainless steel screws.

STEP 11 Install Complete



Thank you for using our products!

TileWare Products
 PO Box 793, Hickory, NC 28603
 Technical Support: 828-322-9273
 Email: info@tilewareproducts.com
www.tilewareproducts.com

Soap Basket Parts List

Basket Quantity 1 per kit	PermaTile™ Fastener Assembly quantity 1 per kit	Standard Ferrule quantity 2 per kit	Thin-tile Washer quantity 2 per kit	Cap quantity 2 per kit	8-32 Screw quantity 2 per kit
255976	PT100-504	255245	C220-020	243168	A008185